

HF SSB transceiver type 9480
Operators handbook



No part of this handbook may be reproduced,
transcribed, translated into any language or transmitted
in any form whatsoever without the prior written
consent of Codan Pty Ltd.

© Copyright 1994 Codan Pty Ltd.

Codan Part No. 15-04047 Issue 2, March 1995

Contents

1. About this handbook.....	1-1
Who should use this handbook	1-1
Icons and standards.....	1-1
Glossary.....	1-2
2. Overview	2-1
The transceiver and control head front panels	2-3
The transceiver and control head rear panels.....	2-7
3. Installation	3-1
Fixed base station.....	3-1
Mobile.....	3-2
Mounting the transceiver	3-3
Code 117 mounting cradle—front entry.....	3-4
Code 118 mounting cradle—top/bottom entry.....	3-5
Mounting the extended control head.....	3-6
Power supply	3-8
Grounding.....	3-9
Antennas	3-9
4. Using the transceiver.....	4-1
Switching the transceiver on or off	4-2
Switching on or off without a PIN	4-2
Switching on or off with a PIN.....	4-3
The transceiver display	4-4
Option codes	4-4
Displaying the channel option.....	4-5
Dimming the display and indicators	4-6
Reviewing the EPROM version and options.....	4-7
Selecting channels.....	4-9

Using the Channel buttons	4-9
Adjusting the volume.....	4-10
Using the clarifier	4-11
Changing the operating mode (USB–LSB).....	4-12
Using the mute control.....	4-13
Voice mute	4-13
Selective call mute	4-13
Tuning the antenna	4-14
Automatic tuning whip antenna.....	4-14
Multi-frequency tapped whip antenna.....	4-15
Antenna tuners	4-16
Transmitting.....	4-18
Using the microphone	4-18
Transmitting a message.....	4-19
Setting up for emergency call transmission	4-21
Making an emergency call	4-23
Automatic method.....	4-23
Manual override	4-24
Setting up to receive an emergency call.....	4-25
Receiving an emergency call	4-28

5. Using selective call5-1

Selective call terms.....	5-2
Setting up selective call	5-4
Setting the preamble time period	5-5
Setting the fixed called address.....	5-6
Setting the self-identification address	5-7
Enabling or disabling selective call lockout.....	5-8
Enabling the beacon mode	5-8
Checking if a channel is enabled for selective call	5-9
Selective call mute enable or inhibit.....	5-10
Enabling a channel for selective call.....	5-12
Transmitting a selective call	5-14
Receiving a selective call.....	5-17
Answering a received call.....	5-18
Returning a received call	5-19
Reviewing the list of received calls in memory	5-20
Reviewing calls held in memory	5-21
Using the beacon feature.....	5-23
Selective beacon mode.....	5-25

	(99) beacon mode.....	5-27
	Using the external alarm feature	5-29
6.	Using the receiver in scan mode	6-1
	Setting up the scan mode	6-2
	Programming the channels to be scanned	6-4
	Receiving in scan mode	6-6
	Start scanning.....	6-6
	Stop scanning.....	6-6
	Changing the scan mode.....	6-7
	Using selective call in scan mode	6-9
7.	Programming channels	7-1
	Setting up the channel inhibit options.....	7-2
	Checking if the inhibit link is fitted to the PCB	7-3
	Changing the inhibit options	7-4
	Creating receive only channels	7-6
	Creating transmit and receive channels.....	7-8
	Deleting unwanted channels	7-11
	Programming display messages	7-12
	Inhibit (inhib).....	7-12
	Used (USED).....	7-12
	Full (FULL).....	7-13
	Too high or too low (too hi or too lo)	7-13
	Setting up temporary channels.....	7-13
8.	Changing the setup options	8-1
	Setup option links	8-1
	The front panel link.....	8-2
	Changing the position of the front panel link	8-3
	The microprocessor PCB link	8-4
	Inserting the microprocessor PCB link	8-5
	Reviewing setup options	8-6
	PTT timer	8-7
	Enter a PIN (Personal Identification Number).....	8-9
	Changing or deleting a PIN	8-11
	Power-on settings.....	8-13
	Mute settings.....	8-13

Beep volume	8-15
9. Display messages	9-1
Messages and operator errors	9-2
System errors	9-5
Reviewing the EPROM program content	9-6
10. Front and rear panel sockets	10-1
Microphone socket	10-2
External alarm socket	10-3
Antenna control socket	10-4
Antenna control—standard	10-5
Antenna control—option AD	10-6
Remote control socket	10-7
11. Specifications	11-1
12. Options and accessories	12-1

List of drawings

Figure	Title	Page
2.1	The transceiver front panel	2-8
2.2	The control head front panel	2-9
2.3	The transceiver rear panel	2-10
2.4	The control head rear panel.....	2-10
3.1	Typical fixed base station installation	3-1
3.2	Typical mobile installation.....	3-2
8.1	The front panel link.....	8-2
8.2	The microprocessor link.....	8-4



Contents





1. About this handbook

Who should use this handbook

This handbook is written for the person who installs and operates the Codan 9480 transceiver.

Icons and standards

The following icons and standards have been used throughout this handbook.

This icon...	Means...
	a Warning. If you do not observe the warning you may damage yourself or the equipment.
	a note or reminder.
	a button on the transceiver.
	an antenna symbol used in drawings.
	the end of a subject.



Glossary

AD	Antenna Driver
LCD	Liquid Crystal Display
LSB	Lower Side Band
PIN	Personal Identification Number
PTT	Press To Talk
R	Remote
Rx	Receive
SD	Selective call Decode
Tx	Transmit
USB	Upper Side Band



2. Overview

Your 9480 HF SSB transceiver employs the latest concepts in design and reliability for long range communications. It has been designed for fixed base station and mobile installations (12V DC operation).

There are two versions of the transceiver; one with front panel control and the other with extended control. The extended control unit consists of a transceiver and a separate control head which can be located up to 100 metres away from the transceiver.

The control head can also be used as an accessory with the front panel control version to enable local and extended control of the transceiver.

You operate the transceiver through the front control panel, or control head, which contains sealed membrane switches (or buttons) and a liquid crystal display (LCD). The LCD shows the selected channel number along with the transmit and receive frequencies. In addition, the display shows messages about the operation of the transceiver.

The main facilities and features of the transceiver are:

- channels
- selective call
- scanning.

Channels

Your transceiver has a capacity of 15 channels, these cover:

- transmit frequency range 2 MHz to 24 MHz
- receive frequency range 0.25 MHz to 30 MHz.

15 transmit and receive channels are pre-programmed in the factory. You, as a user, can also program the channels from the front panel.

Selective call

This facility allows you to transmit a call to a single transceiver or a group of transceivers.

Your transceiver can store details of up to ten stations that have called you while your transceiver was left unattended.







Scanning



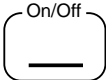

This facility scans selected channels for audio signals. You can program a maximum of 15 channels to be scanned in sequence for audio signals. When a selective call decode is selected, a maximum of eight selective channels can be scanned.



The transceiver and control head front panels

The transceiver and control head front panels (refer to the figures on pages 2-8 and 2-9) have the following control panel designations:

Item No.	Item	Function
1		The indicator is lit when the transceiver is transmitting.
2		Switches the transceiver on or off.
3		<ul style="list-style-type: none"> Shows the options programmed for the selected channel exhibited on the LCD. Is used to interrogate received selective call memory. Keys in the number 1.
4		<ul style="list-style-type: none"> Dims the display and indicators when pressed. Keys in the number 2.
5		<ul style="list-style-type: none"> Keys in the number 3. Is used for PIN setup.
6		Keys in the number 4.
7		Keys in the number 5.

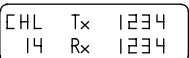
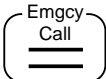
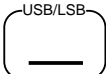
Item No.	Item	Function
8		Keys in the number 6.
9		Keys in the number 7.
10		Keys in the number 8.
11		Keys in the number 9.
12		It selects a selective beacon call and also keys in the number 0.
13		Liquid Crystal Display (LCD) shows the channel number and frequency. It also shows messages regarding the operation of the transceiver.
14		Transmits a digital emergency call.
15		Selects USB or LSB mode. The display indicates which side band is selected.



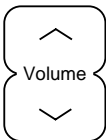
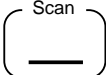
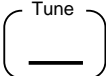



Item No.	Item	Function
16	<input type="checkbox"/> Mute <input checked="" type="checkbox"/> Voice <hr/> <input checked="" type="checkbox"/> S'Call	Mutes all audio until a selective call is received. The indicator is lit when the mute is 'on'.
	<input checked="" type="checkbox"/> Mute <input type="checkbox"/> Voice <hr/> <input type="checkbox"/> S'Call	Removes normal background noise when there is no audio signal. The indicator is lit when the mute is 'on'.
	<input type="checkbox"/> Mute <input type="checkbox"/> Voice <hr/> <input type="checkbox"/> S'Call	Both mutes are off when indicators are not lit.
17		Microphone socket.
18	<input type="button" value="Enter"/>	Selects beacon call to be sent. It is also used to enter data in setup.
19	<input type="button" value="Call"/>	Transmits a selective call or beacon call on the selected channel.
20	<input type="button" value="Clarifier"/>	Raises the received audio frequency in steps of 10 Hz to help clarify the received speech. Reduces the received audio frequency in steps of 10 Hz to help clarify the received speech.
21	<input type="button" value="Channel"/>	Selects the next higher channel. Selects the next lower channel.

Item No.	Item	Function
22		Increases the audio volume. Decreases the audio volume.
23		Selects channel scan.
24		Tunes the antenna (if using an automatic tuning whip antenna).

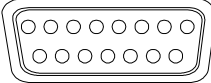

The transceiver and control head rear panels

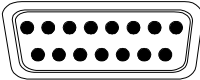
The transceiver and control head rear panels (refer to the figures on page 2-10) show the following items:

Item No.	Item	Function
1		Antenna socket.
2		Earth (ground) screw.
3		Automatic antenna control socket.
4	12 V 	12V DC power lead.
5	L/S 	External 8 ohm loudspeaker socket.
6		Remote control unit socket.
7	RS232 	Serial-input socket used for programming channels via an XP.
8		External alarm.

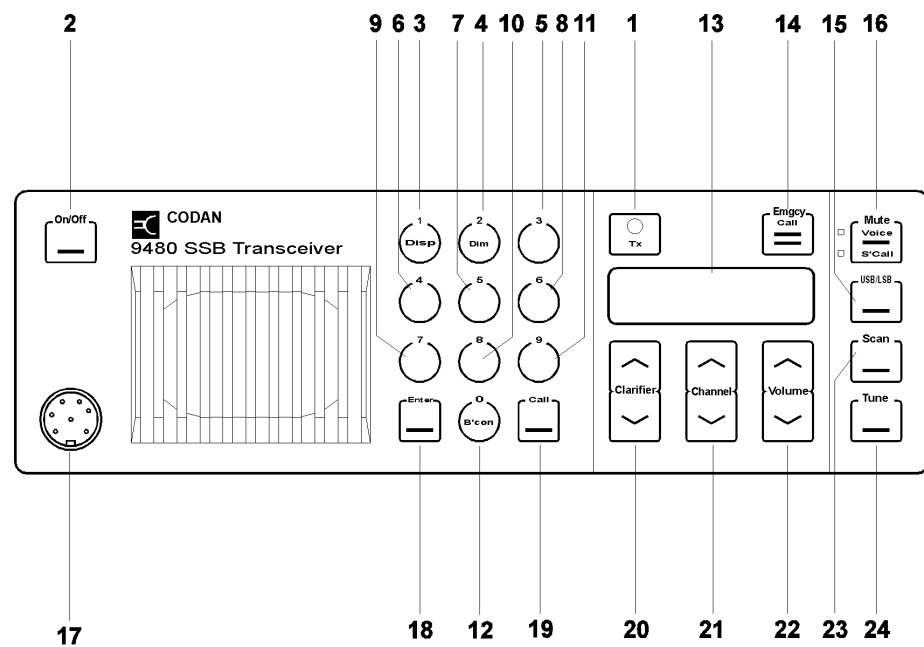

Figure 2.1: The transceiver front panel

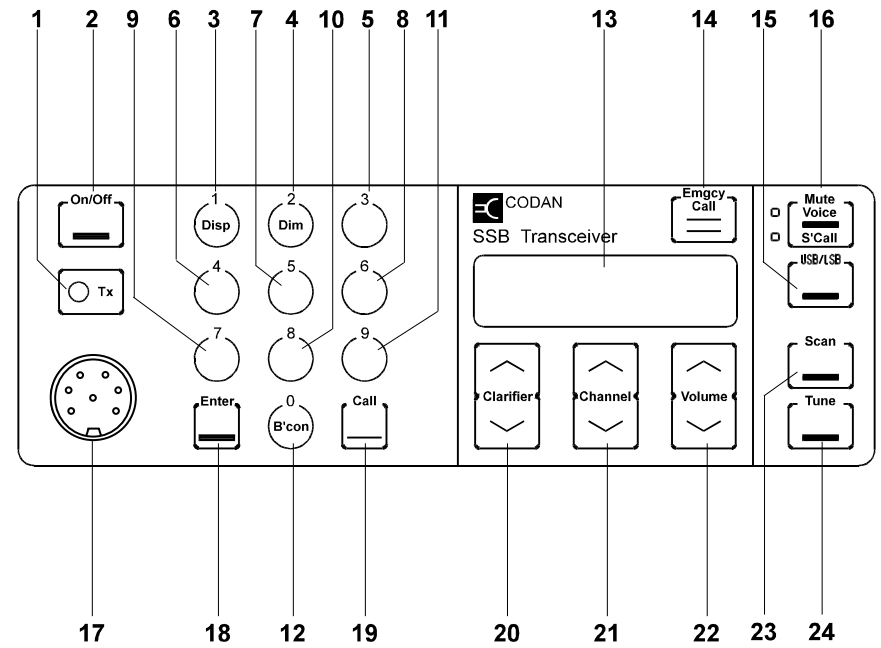

Figure 2.2: The control head front panel

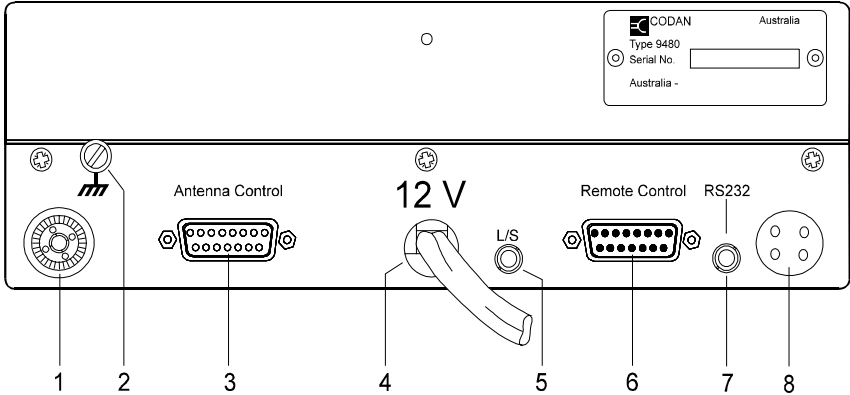

Figure 2.3: The transceiver rear panel

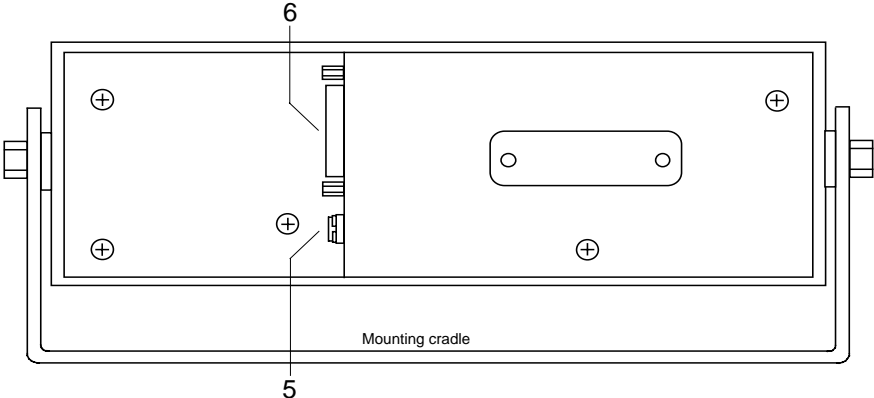

Figure 2.4: The control head rear panel



3. Installation

On receipt of your transceiver, check the contents against the packing list. Ensure all items are available before commencing installation.

The following notes provide guidance to installation but are not intended to be comprehensive procedures. It is recommended that installation is carried out by qualified and experienced personnel.

There are two types of installation:

- fixed base station
- mobile.

Fixed base station

The fixed base station installation (Figure 3.1) typically consists of an AC power supply connected directly to the mains. DC output from the power supply is connected to the transceiver, which in turn is connected to an antenna.

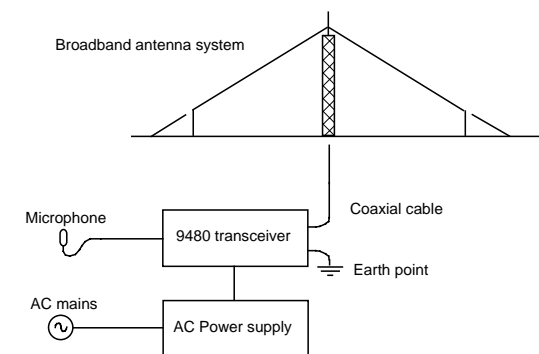

Figure 3.1: Typical fixed base station installation

Mobile

The mobile installation (Figure 3.2) typically consists of a 12V DC power supply (battery) connected to the transceiver; the antenna is connected to the transceiver with coaxial cable and, for auto tuning antennas, with a control cable.

Installations may be either with front control transceivers or extended control transceivers which include a separate control head and speaker.

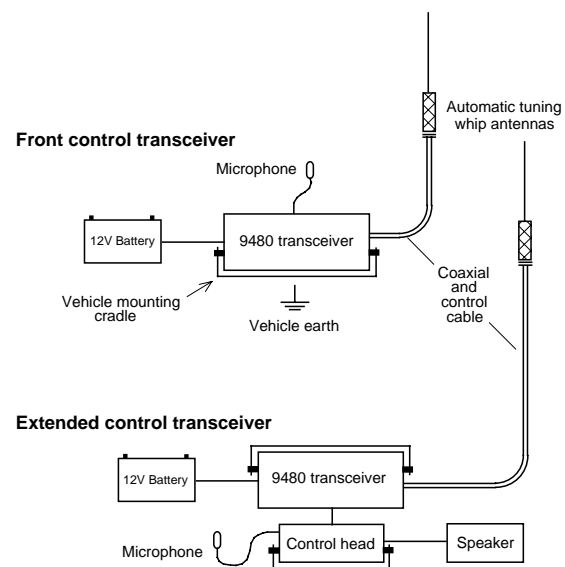

Figure 3.2: Typical mobile installation

Mounting the transceiver



In mobile installations, the transceiver must be mounted in a position that will not cause injury to occupants in the event of a motor vehicle accident.

Mount the transceiver and control head in a position that allows:

- **easy access to the control panel**
- **a free flow of air through the rear cooling fins.**

There are two types of mounting cradles that can be used when installing your transceiver:

- code 117 mounting cradle—front entry (normally supplied with the 9480)
- code 118 mounting cradle—top/bottom entry.

Both types of cradle (supplied with 6 metres of DC power cable) can be used to mount the transceiver. You must determine the mounting position to best suit your needs.

Code 117 mounting cradle—front entry

- Step** **Action**
1. The cradle can support the transceiver from above or below permitting roof or floor mounting.
- Secure the mounting cradle into position with the rotating cam catches to the front. Ensure there is sufficient space at the rear of the cradle to take the transceiver heat sink and connectors.

2. Align both cam catch slots with the T-section slides.

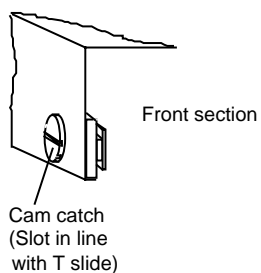

3. Insert the transceiver side rails into the T-section slides and push the transceiver fully into the cradle.
4. Apply gentle pressure to the front panel of the transceiver and lock into the cradle by turning the cam catches one quarter of a turn in either direction with a suitable tool or small coin.



Code 118 mounting cradle—top/bottom entry

- | Step | Action |
|-------------|---|
| 1. | Secure the mounting cradle into position with its spring clips nearest the front. Ensure there is sufficient space at the rear of the cradle to take the transceiver heat sink and connectors. |
| 2. | Remove the front and rear fixing screws of the transceiver side rails (the centre screw to be left untouched).

Note: Adaptor plates have to be fitted to the transceiver side rails to secure the transceiver to the cradle. |
| 3. | Secure the adaptor plates flush to the transceiver side rails with the new screws provided, and fit one 'O' ring over each projecting stud. The adaptor plates projecting studs fit into the slides in the cradle. |
| 4. | Insert the transceiver adaptor plate studs into the cradle slides and push fully into the cradle. |
| 5. | Secure the transceiver into the cradle with the spring clips. |



Mounting the extended control head



The control head must be connected to the transceiver before power is applied. Failure to do this may result in damage to the transceiver in the following ways:

- **the internal fuse blows and must be replaced**
- **the control head fails to operate. The power must be disconnected from the transceiver and then reconnected and switched on.**

Step	Action
1.	Remove the two cradle screws and washers securing the mounting cradle to the control head.
2.	Secure the mounting cradle into position. Ensure there is sufficient space at the rear of the cradle for the control cable.
3.	Secure the control head to the mounting cradle with the two screws and washers.
4.	Mount the transceiver (refer to page 3-3, <i>Mounting the transceiver</i>).

- | Step | Action |
|-------------|--|
| 5. | <p>Connect the interface cable between the control head and transceiver. Ensure the cable connectors are securely fastened to the control head and the transceiver.</p> <p>Notes: If necessary, remove the cover from one connector to pass the cable through restricted openings.</p> <p>If the cable is too long, gather the excess neatly at one point.</p> |
| 6. | <p>Connect the extension speaker cable to either the control head or the transceiver.</p> |



Power supply

Ensure that the power supply to operate your transceiver is 12V DC.

All installations should be checked by a qualified technician before power is applied to the transceiver.

The heavy duty six metre length of power cable—supplied with the vehicle mounting cradle for mobile installations—has been selected to minimise the voltage drop between the battery and transceiver when in transmit mode. Installation using a smaller core cable size is not recommended.

All cables should be protected from sharp edges and mechanical abrasions.

For installation it is recommended that a suitable cartridge fuse (32 Amp—accessory code 711) is fitted in the active wire, close to the battery, to protect the power cable from the possible risk of fire through damaged insulation coming in contact with the vehicle chassis. Normal glass in-line automotive fuses are not recommended. The transceiver is fitted with adequate internal protection.

Connect the power cable between the transceiver and the battery, or the transceiver and AC power supply.



Note: In extended control installations where the power and control cables are long and follow a common path, keep the cables separated by at least 200 mm. The cables can be brought together for short distances, for example, to pass through the same hole in a bulkhead. Failure to observe this warning will cause distortion of the transmitted audio signals.



Grounding

An adequate ground, or earth, is essential for satisfactory operation of the transceiver.

A chassis ground or earthing position is provided on the rear panel of the transceiver.

The control head should also be earthed.



Antennas

Correct installation of these two units is of prime importance to the operation of your transceiver.

To obtain the best performance and good radiation efficiency from your transceiver installation, it is important to consider the physical location (distance from the transceiver) and earthing of the antenna and tuner.

Detailed and specific installation instructions are provided with each antenna and antenna tuner. These instructions must be followed to gain the best possible results from your antenna, antenna tuner and transceiver.



4. Using the transceiver

This section covers the basic steps necessary to operate your transceiver.

It outlines how you use the control buttons to make various adjustments and settings, and includes transmitting and receiving calls.

Throughout this section all displays show examples of channel and frequency numbers. You must insert your selected channel and frequency numbers as appropriate.

Unless otherwise stated, it is assumed throughout this section that:

- the 12V DC power is supplied to your transceiver
- the front panel On/Off button is switched on.

Refer to page 4-2, *Switching the transceiver on or off*.

Switching the transceiver on or off

When you switch the transceiver on, the display usually shows the last settings before the transceiver was switched off. If your transceiver has a personal identification number (PIN) allocated, the display requests you to enter your PIN.

This section covers two methods of switching your transceiver on or off:

- switching on or off without a PIN
- switching on or off with a PIN



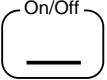
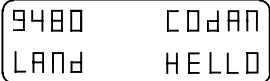
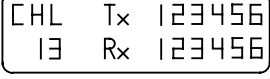
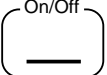

Switching on or off without a PIN

Step	Action...	Display shows...	Remarks...
1.	Ensure power is supplied to your transceiver.		
2.	Press 	You see this display for one second  and then the last channel and frequencies selected 	The Mute and Mode indicators and the LCD display illuminate. The transceiver is turned on and automatically set to the last channel and volume settings used.
3.	To switch off, press 	The display and indicators go off.	The transceiver is turned off.

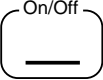

Switching on or off with a PIN

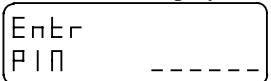
It is most important not to forget your PIN, otherwise you will never be able to switch on your transceiver. If this happens, you will have to return your transceiver to Codan for them to delete the allocated number.

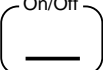
Step	Action...	Display shows...	Remarks...
1.	Ensure power is supplied to your transceiver.		
2.	To switch on, press 	You see this display for one second  and then this display 	The Mute and Mode indicators and the LCD display illuminate.
3.	Use the numeric buttons to enter your PIN.		You must enter the correct PIN, otherwise your transceiver will never turn on to the operating mode.
4.	Press 	The display is automatically set to the last channel and volume settings used.	The transceiver is turned on and can now be operated.
5.	To switch off, press 	The display and indicators go off.	The transceiver is turned off.



The transceiver display

The display provides you with visual indication of the selected channel numbers, and the transmit and receive frequencies. In addition, it shows you messages that will assist you when operating your transceiver. A detailed description of all the messages can be found in Section 9, *Display messages*.

The display and button legends of the front panel are back-lit to give you the clearest view. If necessary, the brightness can be adjusted to suit your needs. Refer to page 4-6, *Dimming the display and indicators*.

This section explains what the option codes mean and how to reveal the option codes on the display.

The display contains two rows of information. Each row is split into three groups. What you see in each group depends on the transceiver mode selected.

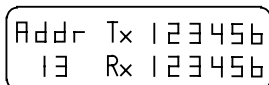

```
Addr Tx 123456
13 Rx 123456
```

Option codes

Code	Description
S	in the far left hand position indicates that selective call is enabled for this channel.
L	indicates the lower side band has been enabled for this channel.
U	indicates the upper side band has been enabled for this channel.



Displaying the channel option

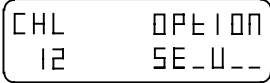

There are several channel options that you can select. The display button allows you to check the options that have been selected at the factory.

Step	Action...	Display shows...	Remarks...
1.	Press 		<p>The option bar indicates the options enabled for the channel currently selected.</p> <p>There are six spaces in the option bar that contain either a code (see Option codes) or an underscore (_). An underscore indicates that no function has been enabled.</p>



Dimming the display and indicators

The backlit display and indicators are at maximum brightness when you switch the transceiver on. This procedure explains how to reduce the brightness of the display and indicators.

Step	Action...	Display shows...	Remarks...
1.	Press 		This reduces the brightness of the indicators and dims the display background lighting. This function does not work when you are in numeric entry mode. Only one dim setting is available.
2.	To restore the brightness, press 		This restores both the display and indicators to their maximum brightness. This function does not work when you are in numeric entry mode.



Reviewing the EPROM version and options

This facility allows you to review the EPROM version and some of the options fitted to your transceiver.

This procedure is repeated in Section 9, *Reviewing the EPROM program content*.

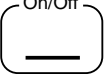
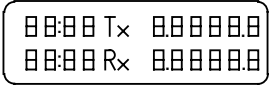
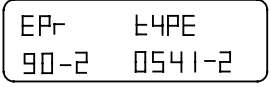
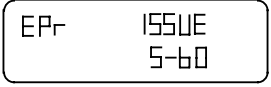
Step	Action...	Display shows...	Remarks...
1.	Ensure your transceiver is switched on.		
2.	Hold down On/Off 	 At three second intervals the display changes and shows the following.	Displays lamp test—all segments must be on and all the indicators lit.
			This shows the Program (EPROM) type number (example 90-20541-2). Some indicator lamps turn off.
			Program (EPROM) issue number. This is an example of EPROM issue 5.60.

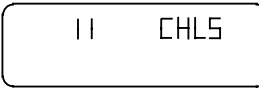
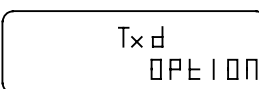
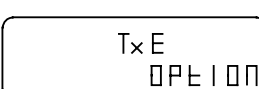
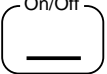
Step	Action...	Display shows...	Remarks...
2. cont.			Shows the number of channels programmed by the factory or agent. This can be up to 15.
	The display indicates the option fitted to your transceiver.		d indicates that the transceiver is inhibited from entering transmit frequencies from the front panel.
			E indicates that the transceiver is enabled for entering transmit frequencies from the front panel
3.	Release On/Off 		This switches off your transceiver.



Selecting channels

Using the Channel buttons

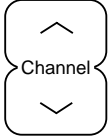
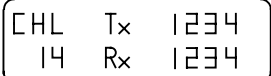
Step	Action...	Display shows...	Remarks...
1.	Press either the up or down arrow 	The channel number selected appears in the lower left hand corner of the display, and the transmit and receive frequencies to the right. 	Pressing these buttons moves to the next higher or lower channel. Keep a button pressed to move quickly through the channels.



Adjusting the volume

This procedure tells you how to adjust the volume. When the mute is on, pressing either of the volume buttons opens the mute for approximately one second. This allows you to hear the background noise, thus assisting you to select the correct level.

When you switch your transceiver on, the volume level is at the last used setting.

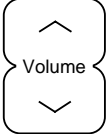
Step	Action...	Display shows...	Remarks...
1.	Press either the up or down arrow 	The display does not change.	Pressing this button either increases or decreases the volume. You hear a 'pip' when the volume control has reached its operating limit.



Using the clarifier

The clarifier buttons raise or lower the frequency in steps of 10 Hz. This allows you to fine tune the transceiver to obtain the best clarity for received voice calls.

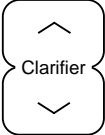
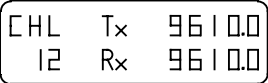
Step	Action...	Display shows...	Remarks...
1.	Press either the up or down arrow 		Adjust for the best clarity using the Clarifier button. You hear a 'pip' when the clarifier control has reached its operating limit. Note: the clarifier resets to the middle frequency when you change channels, or switch off.



Changing the operating mode (USB–LSB)

Your transceiver has the facility to operate in either Upper Side Band (USB) or Lower Side Band (LSB) mode.

Step	Action...	Display shows...	Remarks...
1.	To switch between USB and LSB, press	The display does not change.	The relevant indicator lights up.

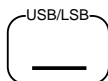



Using the mute control

There are two mute functions on the transceiver:

- Voice—this function inhibits background noise until a voice signal is received.
- S'call—this function inhibits background noise until your transceiver has been selectively called.

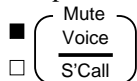
Voice mute

Step	Action...	Display shows...	Remarks...
1.	To switch on and off, press <input checked="" type="checkbox"/>  <input type="checkbox"/> 	The display does not change.	The indicator is lit when this option is selected. Inhibits background noise until a voice call is received.

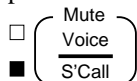
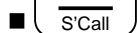

Selective call mute

Step	Action...	Display shows...	Remarks...
1.	To switch on, press <input type="checkbox"/>  <input checked="" type="checkbox"/>  until the S'Call indicator is lit.	The display does not change.	The indicator is lit when this option is selected. Inhibits background noise until a selective call is received.





Tuning the antenna

Before using the selected channel, the antenna must be tuned to the transmission frequency. The procedure used to tune the antenna depends upon the type of antenna you are using. This may be:

- an automatic tuning whip antenna
- a multi-frequency tapped whip antenna
- an antenna tuner with antenna.

The transceiver also has an auto tune facility which automatically tunes the antenna when the Call, B'con or Emgcy button is pressed.

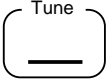
Automatic tuning whip antenna

Step	Action...	Display shows...	Remarks...
1.	Select the required channel.		Refer to page 4-9, <i>Selecting channels</i> .
2.	Press 	<p>If tuning was successful</p>  <p>If tuning was unsuccessful</p> 	<p>The Tx indicator is lit during this procedure.</p> <p>You hear 'pips' while the antenna is tuning.</p> <p>Once tuned successfully you hear two high pitched 'pips'.</p> <p>If tuning is unsuccessful you hear two low pitched tones. For further information, refer to the antenna handbook.</p>



Multi-frequency tapped whip antenna

For specific details on how to use the antenna, refer to the relevant antenna handbook.

Step	Action...	Display shows...	Remarks...
1.	Select the correct tap on the antenna to match the transmit frequency.	The display does not change.	The antenna either has: <ul style="list-style-type: none">• the frequency printed next to the tap• a number that corresponds to a frequency on the list supplied with the antenna.



Antenna tuners

There are two types of antenna tuners, manual and automatic. For specific details refer to the relevant antenna tuner handbook.



Manual

Step	Action...	Display shows...	Remarks...
1.	Select the required channel.		Refer to page 4-9, <i>Selecting channels</i> .
2.	Hold down  while adjusting the antenna tuner.	The display does not change.	



Automatic

There are two models of Codan automatic antenna tuners, the 4203 and the 9103. The 4203 produces display messages on the transceiver; the 9103 does not. Further information on these antenna tuners can be found in the relevant handbooks.

Step	Action...	Display shows...	Remarks...
1.	Select the required channel.		Refer to page 4-9, <i>Selecting channels</i> .
2.	Press 	<p>If tuning on model 4203 was successful</p>  <p>If tuning on model 4203 was unsuccessful</p>  <p>For the 9103, the display is unchanged throughout this procedure.</p>	<p>The Tx indicator is lit during this procedure.</p> <p>You hear 'pips' while the antenna is tuning (this can take between 20 and 30 seconds).</p> <p>Once tuned successfully you hear two high pitched 'pips'.</p> <p>If tuning was unsuccessful you hear two low pitched tones. For further information, refer to the antenna handbook.</p>



Transmitting

It is important when transmitting to use the microphone to its best advantage. By following the notes under *Using the microphone* you will obtain the best transmission results. This section covers two topics:

- using the microphone
- transmitting a message.

Using the microphone

To connect the microphone to the transceiver, push the microphone plug gently into the microphone socket and fasten the locking ring finger-tight. Do not over tighten.

Please observe the following when using the microphone:

- Hold the microphone side-on and close to your mouth.
- Hold down the PTT (Press To Talk) button.
- When starting a transmission, always state the call sign of the person you are addressing and then your own call sign.
- Speak clearly at normal volume and rate.
- Use the word ‘over’ to indicate you have finished speaking and release the PTT button.
- The transceiver has a ‘time out’ facility that stops the transmission after a pre-set period. This facility prevents problems occurring if you have jammed the PTT button down. The ‘time out’ period can be adjusted to suit your requirements—refer to Section 8, *Changing the setup options*.



Transmitting a message



Step	Action...	Display shows...	Remarks...												
1.	Select a channel for transmission.	The display shows the channel number and the transmit (Tx) and receive (Rx) frequencies.	Refer to page 4-9, <i>Selecting channels</i> .												
2.	Check the display to see if the channel transmit frequency has been enabled.	<div style="border: 1px solid black; padding: 5px; display: inline-block;"> <table style="border-collapse: collapse;"> <tr> <td style="padding: 2px 10px;">[HL</td> <td style="padding: 2px 10px;">Tx</td> <td style="padding: 2px 10px;">4321</td> </tr> <tr> <td style="padding: 2px 10px;">12</td> <td style="padding: 2px 10px;">Rx</td> <td style="padding: 2px 10px;">4321</td> </tr> </table> </div> <p>If the display shows 'inhib' then the channel frequency is receive only.</p> <div style="border: 1px solid black; padding: 5px; display: inline-block;"> <table style="border-collapse: collapse;"> <tr> <td style="padding: 2px 10px;">[HL</td> <td style="padding: 2px 10px;">Tx</td> <td style="padding: 2px 10px;">i n h i b</td> </tr> <tr> <td style="padding: 2px 10px;">15</td> <td style="padding: 2px 10px;">Rx</td> <td style="padding: 2px 10px;">3600</td> </tr> </table> </div>	[HL	Tx	4321	12	Rx	4321	[HL	Tx	i n h i b	15	Rx	3600	<p>If the channel has been enabled, continue with step 3.</p> <p>If the channel has not been enabled and the display shows 'inhib', select another channel on which to transmit.</p>
[HL	Tx	4321													
12	Rx	4321													
[HL	Tx	i n h i b													
15	Rx	3600													
3.	Tune the antenna.		Refer to page 4-14, <i>Tuning the antenna</i> .												
4.	Listen and check that the channel is free from traffic.														



Step	Action...	Display shows...	Remarks...
5.	Press the PTT button on the microphone and commence talking. Transmit your message following the notes outlined in <i>Using the microphone</i> on page 4-18.		The Tx indicator flashes during transmission.

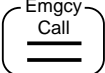
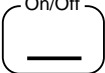
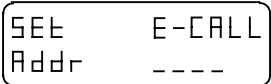

Setting up for emergency call transmission

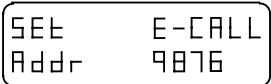
In order to use the Emergency Call feature several setup steps must be undertaken.

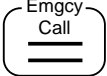
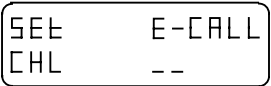
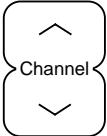
Step	Action...	Display shows...	Remarks...
1.	With the transceiver switched off, hold down  then press 		The display indicates the emergency selcall ID has not been programmed.
2.	Press the appropriate numeric keys followed by 		In this example, selcall ID 9876 has been input. This is the only address to which a digital emergency call can be sent. If the ID you enter ends in a double zero (group call), the call may be responded to by 100 transceivers.

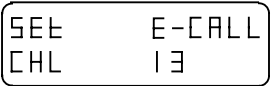
Step	Action...	Display shows...	Remarks...
3.	Press 		The display indicates the channel number, on which digital emergency calls will be sent, has not been set. If you do not set a channel number, the call will be sent on the channel already selected at the time.
4.	To select the required channel, press either the up or down arrow   then press 		The emergency call will be transmitted on channel 13 unless manual override is used. Refer to page 4-24, <i>Manual override</i> .

Note: If you do not wish to receive emergency calls, you can switch your 9480 transceiver off at this point. If you want to be able to receive emergency calls, refer to page 4-25, *Setting up to receive an emergency call*, from step 3 onwards.



Making an emergency call

The Emergency Call button is used to transmit a digital emergency call to a preset station address. There are two ways you can transmit a digital emergency call:

- automatic method
- manual override.

Automatic method

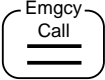
Step	Action...	Display shows...	Remarks...
1.	Hold down  for two seconds.		<p>During this two second period the transceiver generates 'pip' sounds.</p> <p>The transceiver immediately changes to the preset emergency channel. If no channel has been preset, the current channel is used. Refer to page 4-21.</p> <p>After the two seconds has elapsed, automatic tuning begins regardless of whether the channel has been previously tuned.</p> <p>After the tune sequence terminates, the emergency call is transmitted to the preset station selcall ID regardless of whether the automatic tune process succeeded.</p>



Manual override

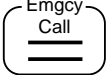
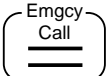





Step	Action...	Display shows...	Remarks...
1.	Press  and release within two seconds.		This overrides the automatic method. During the two second period the transceiver generates 'pip' sounds.
2.	During the next 30 seconds you can search for a channel on which to send the emergency call.		Refer to page 4-9, <i>Selecting channels</i> If you need more time to select a suitable channel, press any button on the transceiver to restart the 30 second period.
3.	During the 30 second period, hold down  for two seconds.		This causes a digital emergency call to be sent on the channel already selected at the time. After 30 seconds of user inactivity, the Emergency button reverts to its automatic operation.



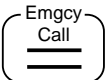
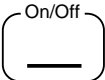
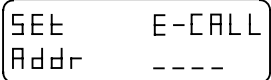

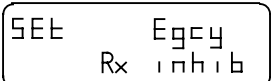

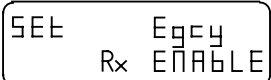

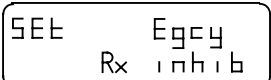

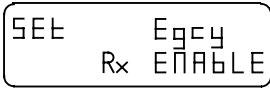
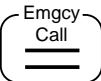
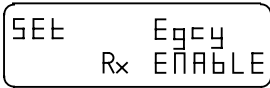

Setting up to receive an emergency call

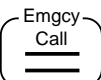
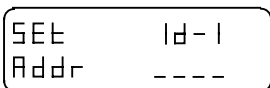

It is recommended that only base stations are set to receive emergency calls as they have broadband antenna systems and the emergency revertive siren is instantaneous. A different station setup may cause a delay on the revertive siren.

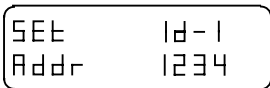
Step	Action...	Display shows...	Remarks...
1.	Hold down  then press 		The display indicates the emergency selcall ID has not been programmed.
2.	Press 		The display indicates that the transceiver will not respond to incoming digital emergency calls.
3.	Press any  or  button		The transceiver will respond from now on.
4.	Press any  or  button		Toggled off again.

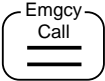
Step	Action...	Display shows...	Remarks...
5.	Press any  or  button		The transceiver will now respond again.
6.	Press 		The transceiver will only respond to digital emergency calls addressed to this transceiver, Id-1 or Id-2.
7.	Press any  or  button. Go to Step 11.		The transceiver will respond to any digital emergency calls regardless of Id. If left enabled, Id-1 and Id-2 cannot be entered.
8.	Press 		The display indicates the first additional ID to which this transceiver will respond has not been entered yet.
9.	Press the appropriate numeric keys followed by 		For example, the transceiver will now respond to digital emergency calls directed to its own ID as well as 1234.

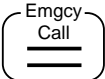
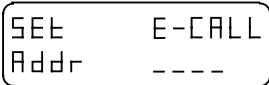
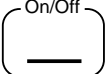
Step	Action...	Display shows...	Remarks...
10.	Press 		The display indicates the second additional ID to which this transceiver will respond has not been entered yet.
11.	Press 		This takes you back to the start of the procedure.
12.	Press 		The setup operation is complete.



Receiving an emergency call

When receiving a digital emergency call, the following occurs if reception of digital emergency calls is enabled and the destination selcall ID was the receiving transceiver's ID, either of the two optional 'Respond IDs' or is within the range of a 10's or 100's call.

1. Transmits a siren sound for five seconds.
2. Displays 'E-Call xxxx' (just like an ordinary selcall but with 'E-' in front) on the display, where 'xxxx' is the Self ID of the calling station.
3. The transceiver queues the received call in the call stack, keeping emergency calls at the top of the stack.
4. Maintains an audible alarm sound for 5 minutes (or until user interaction occurs).
5. External alarm contacts pulse on and off at a rate of 350 ms for 5 minutes.
6. After the 5 minute period has expired, the transceiver generates the 'called pips' (every 4 seconds) as for normal unacknowledged selcalls.



5. Using selective call

Selective call allows you to call an individual transceiver or a group of transceivers. This can be likened to a normal telephone system where the called station has a unique calling address or number. However, the operator can also call a group of stations if desired.

Each transceiver has its own identification number. The identification number is a four digit code that you program into the transceiver using the front panel buttons.

The selective call feature operates by the transmission and reception of coded signals. These signals contain the identification number of the transceiver being called (the called address) and the number of the transceiver making the call (the self-identification).

All displays in this section show examples of channel and frequency numbers. You must insert your selected channel and frequency numbers.

Selective call terms

The following terms are used in this section.

This term...	Means...
Decoding	Receiving and translating the encoded message.
Encode	The translation of the identification number and instructions into a coded message for transmission.
Group call	A call to all transceivers within a selected group. For example, a call using the identification address 0200 (group call) will be received by all transceivers whose identification address falls in the two hundred digit range (0201 to 0299).
Preamble	Part of the coded selective call message structure which is transmitted when you press the Call button. The message contains the preamble tone which precedes the called address and the self-identification address codes.
Program	Setting the identification addresses into the transceiver.
Revertive Signal	<p>A signal automatically transmitted back from the receiving transceiver to indicate message received and decoded satisfactorily.</p> <p>This signal does not apply to group calls.</p>
Selective beacon call	A call used to check signal conditions to a selected station.

This term...	Means...
Self-identification	The four digit identification number of the calling transceiver.
Station	A term used for the location of a transceiver, either mobile or fixed based.



Setting up selective call

There are several features that need to be set up before selective call is used:

- the preamble time period
- the called address
- the self-identification address
- the 99 beacon.

You may cancel the procedure at any time by turning the transceiver off. Turning the transceiver off stores any changes you made to the features.

Once you have commenced this procedure, if no action is required you can skip through all the features by repeatedly pressing the Call button.





Notes: A long preamble is required when scanning selective calls.

The reason for a long preamble is that during scanning, the preamble has to be present throughout the time it takes to scan all eight selective call channels.

Do not use identification addresses ending in '00' and '99' as they are used for the group call and beacon facilities.

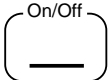
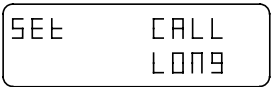
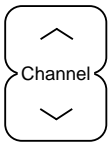
You must always enter information within 60 seconds of pressing the Enter button, otherwise the transceiver reverts to the normal mode.

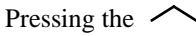
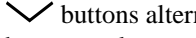
Setting the preamble time period



Step	Action...	Display shows...	Remarks...
1.	Ensure your transceiver is switched off.		
2.	Hold down  and press 		Hold the Call button down for approximately three seconds. This turns the transceiver on and into the preamble setup mode.
3.	Press  to set the preamble length.	 or 	Pressing the  or  buttons alternates between a long and short preamble.
4.	Press 		Once enter has been pressed, the preamble time has been set and can only be changed by repeating this procedure. If your transceiver has the preset selective calling switches fitted, proceed to step 6.

Setting the fixed called address

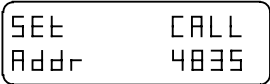

There are two ways of entering the called address:

- a) as below, which is fixed and cannot be changed easily
- b) by the method used on page 5-14, *Transmitting a selective call* (Open access selective call) which allows the address to be entered from the front panel and is easy to change to call another transceiver.

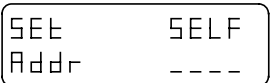

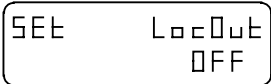

Note: By setting a fixed called address the normal function of Call will change. If a fixed call address has been set, pressing Call will automatically send the programmed address. Open access selective calling is disabled.

Step	Action...	Display shows...	Remarks...
5.	Use the numeric buttons to enter the called address number. To delete an address, enter four zeros.		You can override an existing address by entering a new number.
6.	Press 		Once Enter has been pressed, the called address has been set and can only be changed by repeating this procedure. If your transceiver has the pre-set selective calling switches fitted, proceed to step 8. The next step must be completed within 60 seconds.

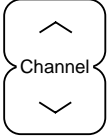

Setting the self-identification address

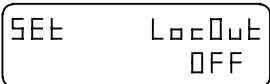
Step	Action...	Display shows...	Remarks...
7.	Use the numeric buttons to enter the self-identification address number. To delete an address, enter four zeros.		You can override an existing address by entering a new number.
8.	Press 		Once Enter has been pressed, the self-identification address has been set and can only be changed by repeating this procedure. The next step must be completed within 60 seconds.

Enabling or disabling selective call lockout

Step	Action...	Display shows...	Remarks...
9.	Press  to switch the selective call lockout on or off.	Changes to:  or 	Selective call lockout prevents the user from transmitting a selective or beacon call if the transceiver detects that another station is making a call.
10.	Press 		This completes the setting. The next step must be completed within 60 seconds.

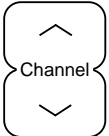
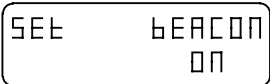
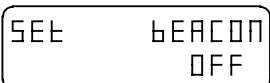

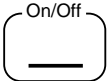
Enabling the beacon mode

Step	Action...	Display shows...	Remarks...
11.	Press  to switch the beacon on or off.	 or 	Repeatedly pressing the  or  buttons switches the beacon on and off. For more information on this feature, refer to page 5-23, <i>Using the beacon feature</i> .
12.	Press 		This turns your transceiver off and registers all the new selective call settings.



Checking if a channel is enabled for selective call

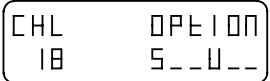



A channel must be enabled for the selective call facility to operate. If the channel you wish to use has not been enabled, refer to page 5-12, *Enabling a channel for selective call*.

Step	Action...	Display shows...	Remarks...
1.	Hold down 		An S in the left position of the options bar indicates that the channel is enabled for selective calling.
2.	Release 		The display returns to its original display in approximately one second.

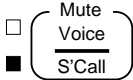

Selective call mute enable or inhibit

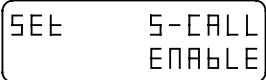
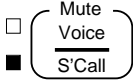
This facility enables or inhibits the operation of the S'call Mute function. When S'call Mute is inhibited, you cannot operate selective call mute.

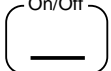
Step	Action...	Display shows...	Remarks...
1.	Turn the transceiver off and move the front panel link to position 1.	No display.	Before moving the link, note its original position. Refer to Section 8, <i>Changing the position of the front panel link.</i>
2.	Hold down  and press 	Hold the Mute button down until the display shows 	Repeatedly pressing Mute switches between enable and inhibit (inhib).
3.	Press 		Stop at the selection you require.
4.	Press 	No display.	The transceiver is now switched off.







Step	Action...	Display shows...	Remarks...
5.	Return the front panel link to its original position (E or F).		Refer to Section 8, <i>Changing the position of the front panel link.</i>
6.	Replace the cover before switching on your transceiver.		



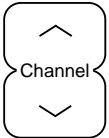
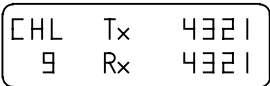

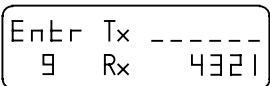

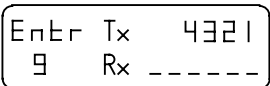
Enabling a channel for selective call

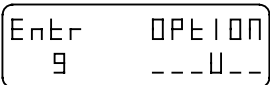
This procedure explains how to enable an existing programmed channel for selective calling.

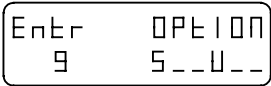
The displays in this section vary depending on the channel you select.

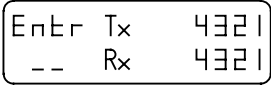
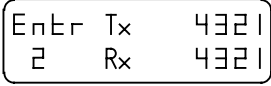

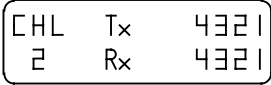
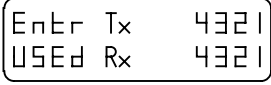
Step	Action...	Display shows...	Remarks...
1.	Use  to find the channel you wish to enable.		This is an example for channel 9. Refer to Section 4, <i>Selecting channels</i> .
2.	Press 		You hear a 'pip'.
3.	Press 		You hear a 'pip'.
4.	Press 		You hear a 'pip'. The display shows the individual options for the chosen channel.





Step	Action...	Display shows...	Remarks...
5.	Press  repeatedly until an S appears in the left hand position of the options bar.		You hear a 'pip'.
6.	Press 		You hear a 'pip'.
7.	Use the numeric buttons to enter the channel number you wish to use.		
8.	Press 	 If the channel is already used the display shows 	
9.	If the channel is already used, you can either enter another number or press Enter again to override the existing one.	The display reverts to normal.	The information will either be stored under an existing channel number or you will have created a new one.

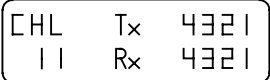
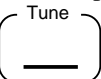

Transmitting a selective call

For selective call to operate you must have your self-identification number programmed, refer to page 5-7, *Setting the self-identification address*.

Step	Action...	Display shows...	Remarks...
1.	Select the channel.		<p>Ensure the channel is enabled for selective calls.</p> <p>Press the 'Disp' button to view the enabled options. If you need to enable the channel, refer to page 5-12, <i>Enabling a channel for selective call</i>.</p>
2.	To tune the antenna, press 		Refer to Section 4, <i>Tuning the antenna</i> .
3.	Press <input type="checkbox"/>  to turn the Mute button to the off position.	The display does not change.	The indicator turns off and you hear background noise.

Step	Action...	Display shows...	Remarks...
4.	Press Call 		The screen displays the 4-digit address of the station you last called on this channel (1374 in this example). No address is displayed if this channel has never been used for making selective calls. If the address is correct, go to step 6.
5.	Use the numeric buttons to enter the address of the station you want to call.		In this example, you are calling station 1144.
6.	Check that the channel is free from traffic.	The display does not change.	Listen for approximately 10 seconds to ensure the channel is free. If the channel is busy, wait until the channel is free or try another channel.
7.	Press Call 	The display does not change.	The Tx indicator is lit and you hear a 'warbling' sound for approximately 10 seconds.

Step	Action...	Display shows...	Remarks...						
8.	If the other station received your call successfully, you hear the short tones of the revertive signal after a few seconds.	<table border="1"><tr><td>CHL</td><td>Tx</td><td>4321</td></tr><tr><td> </td><td>Rx</td><td>4321</td></tr></table>	CHL	Tx	4321		Rx	4321	<p>You hear nothing if this is a group call.</p> <p>You can now speak to the other station.</p>
CHL	Tx	4321							
	Rx	4321							



Receiving a selective call

Step	Action...	Display shows...	Remarks...
1.	No action. The transceiver automatically completes this event.	 <p>When you receive a call the display changes to show you the self-identification address of the calling station.</p>	<p>When you receive a call, you hear tones.</p> <p>You hear a series of three telephone rings for selective calls, and 16 short 'beeps' for group calls.</p>

Notes: On receipt of a call you have two options:

- either answer it immediately. Refer to page 5-18, *Answering a received call*
- let the transceiver automatically store the caller's self-identification number in memory to await your reply, refer to page 5-19, *Returning a received call*.

If your transceiver was unattended at the time the selective call was received, the callers self-identification number is stored in memory for you to review at a later time. Refer to page 5-20, *Reviewing the list of received calls in memory*.

If you do not answer the call immediately, once the call is stored in memory your transceiver continues to emit 'pips' every four seconds to indicate that a call has been received. If you wish to silence these 'pips' yet still retain the display, press the 'Disp' button.

If you only wish to receive selective calls, ensure the S'Call Mute indicator is lit.

If the microphone PTT button is not pressed before the end of the tones:

- the called display remains on to indicate that a call was received
- a 'pip' is heard every four seconds
- the external alarm relay contacts close for approximately two minutes (refer to page 5-29, *Using the external alarm feature*).



Answering a received call





This procedure is used when you want to answer a call that has just been received while your transceiver is still producing a ringing tone.

Step	Action...	Display shows...	Remarks...
1.	The display shows the channel number and the identification address of the caller.		
2.	Press the microphone PTT button twice in succession.	The display either reverts to the normal display or shows the details of the next (if any) unanswered calls.	The first press of the PTT button cancels the call and the S'call mute. The second press of the PTT button allows you to transmit to the caller.

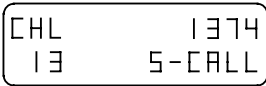

Returning a received call

This procedure is used when you want to return a call that has been stored in the memory stack.

Step	Action...	Display shows...	Remarks...
1.	Select the call you wish to return. If necessary, tune the antenna.	 The display shows the channel number and the identification address of the caller.	Refer to page 5-20, <i>Reviewing the list of received calls in memory.</i>
2.	Press 	 The call details are now deleted from memory, but ready to transmit.	
3.	Check that the channel is free from traffic, then press 	The display shows the details of the next unanswered call.	The transceiver sends the selective call and the transmit indicator will light. If the call is answered, proceed to use the transceiver in the normal way. The caller details are deleted when you press the PTT button on the microphone.



Reviewing the list of received calls in memory

Your transceiver is able to record up to 10 calls in memory from various stations. These may be on different channels if your transceiver is in scan mode. These calls are recorded in a memory stack awaiting your review. If a station calls more than once on the same channel, your transceiver only records one of the calls. If more than 10 calls are made to your transceiver, the first call stored in memory is deleted to make room for the latest call.

Ensure your transceiver is not in scan mode before commencing this procedure.



A loss of power to your transceiver will delete information stored in memory. Ensure you record or use all the information stored in the memory stack before switching off the transceiver.

Notes: If the transceiver power is lost momentarily (such as during starting the vehicle engine), the call memory is retained but the number is lost.



Switching the transceiver off using the On/Off button deletes all calls stored in the memory stack.



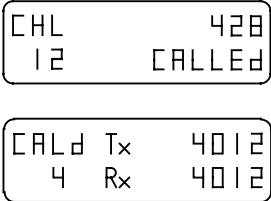

The Disp button is used to review the list of received calls held in the memory.

Reviewing calls held in memory

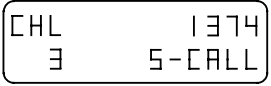
This procedure allows you to review all calls held in the memory in the order received. Ensure the transceiver is not in scan mode when reviewing the list of selective calls received.

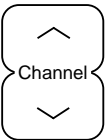
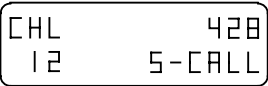
If no calls have been made to your transceiver, the display continues to show both the channel and frequency numbers.

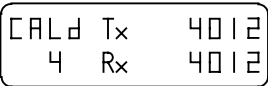
Step	Action...	Display shows...	Remarks...
1.	<p>No action, this is what you see on the display of your transceiver.</p> <p>If your transceiver is scanning, and as it is not on the channel that called, the display shows 'CALd'.</p>		The last call recorded is displayed.
2.	<p>To view the calls held in memory, press</p>  <p>twice within one second.</p>		<p>The first station to call is displayed first.</p> <p>The display shows the callers identification code (1374) and the channel used (3).</p>

Step	Action...	Display shows...	Remarks...
3.	Press either the up or down arrow 		Pressing  changes the display to show the next call. Pressing  reverses the order viewed. The identification address and corresponding channel number change for each caller.
4.	If you wish to return a call, refer to page 5-19, <i>Returning a received call.</i>		
5.	To delete a call, press the PTT button on the microphone.	The display shows the next caller's details.	When you press the PTT button, the identification number in the display is deleted from memory. You can then select, call or clear the remainder of the calls from memory.
6.	If you don't clear all the calls, the display shows 'CALd' until memory is empty.		If you are on the channel where the call was recorded, the display from step 1 is shown.
7.	Press 	The display shows the standard display.	This returns the transceiver to normal operation.



Using the beacon feature

The beacon facility is used to check signal conditions between two transceivers fitted with selective call.

The beacon facility has two modes of operation:

- selective beacon mode
- base station (99) beacon mode.

Selective beacon mode

When the beacon facility is enabled, the transceiver transmits a beacon signal on receiving a selective beacon call from another transceiver. Refer to page 5-25, *Selective beacon mode*.

Both transceivers must be on the same channel, or the receiver of the selective beacon call must be scanning through the same channel.

(99) beacon mode

The 99 beacon mode is recommended for use in base station applications and for those transceivers that may have operating selective call but do not have the beacon mode facility.

When a base station is enabled for beacon mode, the transceiver transmits a beacon signal on receiving a selective call ending in 99. Refer to the *(99) beacon mode* procedure on page 5-27.

The thousand and hundred digits of the address must be the same for both the beacon transmitting and receiving stations.

If mobile transceivers have the beacon enabled, the first two digits of each mobile transceiver's self-identification address should be set to a different number so that they do not all transmit a beacon response together.

General information for both modes of operation

The beacon signal consists of four long tones.



Self-identification addresses ending in 99 should be avoided as these cause confusion.



No alarm or call is recorded at the receiving transceiver, only the Tx indicator flashes.

If the receiving transceiver is in scan mode, the scan sequence recommences immediately.

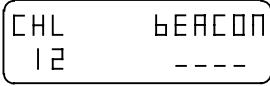
Normal selective call operation is not affected.



Selective beacon mode



Step	Action...	Display shows...	Remarks...
1.	Ensure your transceiver is switched on.	The last channel selected.	
2.	Select the required test channel and tune the antenna.		Refer to Section 4, <i>Selecting channels</i> .
3.	Press 		When this button is pressed, the S'call Mute is automatically switched off.
4.	Use the numeric buttons to enter the required selective call address number.		This allows you to send a selective call to a station whose address number is 1374.

Step	Action...	Display shows...	Remarks...
5.	Check that the channel is free from traffic, then press 	 Immediately after the call is received, the display shows the last channel, transmit and receive frequencies used.	<p>The transmit indicator is lit and you hear a warbling sound for approximately 10 seconds. If the call is successfully decoded you hear four long reverive tones.</p> <p>You can check these tones for signal strength and compare them with signal strengths from other channels. Select the channel giving the best return signal strength.</p>



(99) beacon mode

Step	Action...	Display shows...	Remarks...
1.	Ensure your transceiver is switched on.	The last channel selected.	
2.	Select the required test channel and tune the antenna.		Refer to Section 4, <i>Selecting channels</i> .
3.	Press 		When this button is pressed, the S'call Mute is automatically switched off.
4.	Use the numeric buttons to enter the required selective call number. Use the first two digits of the stations self identification number and ensure the last two are 99.		This sends a signal to the base station enabled for beacon call, whose four digit self-identification address begins with 13.

Step	Action...	Display shows...	Remarks...
5.	Check that the channel is free from traffic, then press 	 Immediately after the call is received, the display shows the last channel, transmit and receive frequencies used.	<p>The transmit indicator is lit and you hear a warbling sound for approximately 10 seconds. If the call is successfully decoded you hear four long reverive tones.</p> <p>You can check these tones for signal strength and compare them with signal strengths from other channels.</p> <p>Select the channel giving the best return signal strength.</p>



Using the external alarm feature

If your transceiver has option SD fitted, an external alarm facility is made available through the external alarm socket on the rear panel (refer to Section 2, *The transceiver and control head rear panels*).

A pair of relay contacts are wired to the socket, which close for two minutes when your transceiver receives a selective call. The relay contacts can be used to operate an alarm bell or buzzer.

- Relay contact rating: 50V DC, 1 Amp
- Plug connections: pins 2 and 3.

Further details on the socket can be found in Section 10.



These contacts must not be used to switch voltages greater than 50V, or loads that draw more than 1 Amp.



Using selective call



CODAN

6. Using the receiver in scan mode

In the receiver scan mode your transceiver is able to listen on selected channels for transmitted signals. Once a signal has been detected, the transceiver holds that channel for a pre-selected time before continuing with the scan. This is determined at setup.

In normal operating conditions, a maximum of 15 channels can be programmed to be scanned in sequence for audio (voice) signals. A maximum of eight selective call channels can also be included but must be programmed within the first eight entries.

The scanning facilities can only be used with a suitable antenna system. Mobile installations require a Codan automatic tuning whip antenna.





It is assumed that before you use any of the procedures in this section, you have turned on the transceiver unless otherwise requested.

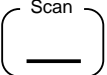
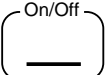
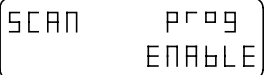
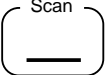

All displays in this section show examples of channel and frequency numbers. You must insert your selected channel and frequency numbers.

Setting up the scan mode

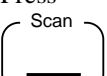
The scan program allows your transceiver to scan a selected number of frequencies. Your transceiver also has the option to run in normal or Auto-scan mode. The Auto-scan mode automatically puts the transceiver back into scan after five minutes of inactivity (such as no channel change, PTT and tune). These scan facilities have two options:

- Enabled—scan programs can be entered and deleted from the front panel
- Inhibit—scan programs cannot be entered or deleted from the front panel.

Step	Action...	Display shows...	Remarks...
1.	With the transceiver switched off, hold down  and press 	Hold down the Scan button until the display shows 	This turns on the transceiver in scan setup mode.
2.	Press 		Each press of the Scan button scrolls to the next option. If this is the option you want, go to step 6.
3.	Press 		Switches to Auto option. If this is the option you want, go to step 6.

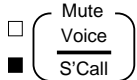
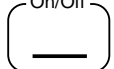
Step	Action...	Display shows...	Remarks...
4.	Press  Pressing the Scan button again returns you to the display in step 1.		Switches from inhibit (inhib) to enable.
<p>Note: If you select automatic scanning, you have the option of selecting Selective Call Mute to be enabled as soon as you enter the automatic scan mode. If you wish to select this option, go to step 5. If you do not wish to select this option, go to step 6.</p>			
5.	Press 	The display does not change.	The S'Call indicator is lit. You have now selected selective call mute to be enabled as soon as you enter the automatic scan mode.
6.	Press 	No display.	Your selection has been made and the transceiver is now switched off.



Programming the channels to be scanned

In normal operating conditions, a maximum of 15 channels can be programmed to be scanned in sequence for audio (voice) signals. Channels required to operate on a selective call must be programmed within the first eight entries.

Ensure your transceiver is switched on and scan program has been enabled.

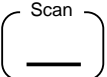
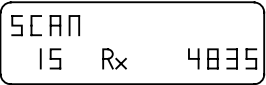
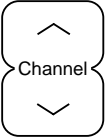
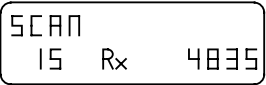
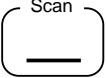
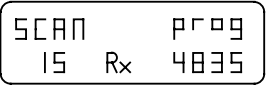
Step	Action...	Display shows...	Remarks...
1.	Press  and then  within one second.		The Scan indicator flashes. Any previous channels programmed to be scanned are erased.
2.	Select the relevant channel. Press 		Refer to Section 4, <i>Selecting channels</i> . Channels required to operate on selective call must be enabled.
3.	Press 		The channel is programmed for scanning. Repeat this procedure until all channels you want to scan have been programmed.

Step	Action...	Display shows...	Remarks...
4.	Press  and then  within one second.		The channels you have programmed are now set within the transceiver.

Notes: If an error is made, the programming mode must be switched off (follow step 4) and the procedure repeated.

If you try to program more than 15 entries, you hear a single low-pitched tone and the error message 'scan full' is displayed.

The channel entries can be reviewed while in the scan programming mode. Use the channel button to scroll through the channels. Any channel in the scan program is indicated by 'prog' on the display (as shown in step 3 above).

The scan program can be inhibited, refer to page 6-2, *Setting up the scan mode*.



Receiving in scan mode

This procedure covers three topics when receiving in scan mode:

- start scanning
- stop scanning
- changing the scan mode.

Start scanning

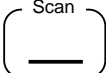
Step	Action...	Display shows...	Remarks...
1.	Press 	The display shows details of each channel as it is scanned.	The Scan indicator is lit during scanning.

Notes: You cannot transmit while the transceiver is in scan mode. If you attempt to transmit, you hear a single 'pip' and the error message 'No PTT Error' is displayed.

If you need to transmit, you must stop the scanning operation.

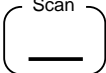

Stop scanning

Step	Action...	Display shows...	Remarks...
1.	Press  or press the microphone PTT button twice.	The display shows the last channel scanned.	The Scan indicator is no longer lit.

Note: If you only press the PTT button once, the display shows 'NO PTT Error'





Changing the scan mode

There are three voice scan mode options available to you which can be selected by repeatedly pressing the Mute button. Your transceiver must be in scan mode to complete this operation (refer to page 6-6, *Receiving in scan mode*).

- Pause scanning. Scanning stops for five seconds when an audio signal is detected.
- Hold scanning. Scanning stops when an audio signal is detected, and continues only when the signal ceases.
- Continuous scanning. Each channel is monitored for one second. Scanning continues regardless of any audio signals being detected.

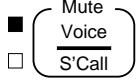
Note: scan modes operate for both voice and selective call reception

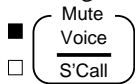
Step	Action...	Display shows...	Remarks...
1.	Ensure the transceiver is in scan mode.	The display shows the frequencies as they are scanned.	The Scan indicator is lit in Scan mode. Refer to page 6-6, <i>Receiving in scan mode</i> .
2.	Pause scanning Press once 		You hear a single 'pip' and the Voice indicator is lit. If you want <i>Hold scanning</i> , go to step 3. To exit this mode go to step 5.

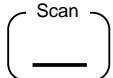
Step	Action...	Display shows...	Remarks...
3.	Hold scanning Press again 		You hear two 'pips' and the Voice indicator is lit. If you want <i>Continuous scanning</i> , go to step 4. To exit this mode go to step 5.
4.	Continuous scanning Press again 		You hear a single 'pip' and the Voice indicator is off.
5.	To exit this mode, press 		



Using selective call in scan mode

Selective call scanning ensures that you are only alerted when the incoming calls are specifically addressed to you.

This facility also allows the transceiver to store in memory the addresses of up to ten stations that may have tried to contact the transceiver whilst it was unattended. These addresses may have been transmitted over any of the programmed channels.

The first eight channels of the scan are used for selective call scanning.

For networks using this facility, it is important for the calling station to transmit a long preamble. For more details on selective calling, refer to Section 5, *Using selective call*.

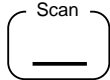
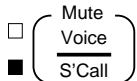
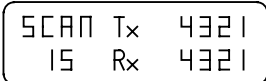
Step	Action...	Display shows...	Remarks...
1.	Press 	The display shows each channel as it is scanned.	The Scan indicator is lit.
2.	Press  button until S'Call indicator is lit.		On detection of a call, scanning stops until the call is decoded. If the call is addressed to your transceiver you hear a series of three telephone rings followed by 'pips' every four seconds. If the call is not addressed to your transceiver, the scan continues.

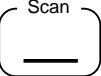
Step	Action...	Display shows...	Remarks...
3.	<p>If the call is addressed to the transceiver the display changes.</p> <p>Every time an addressed call is detected, the display repeats the same message with the appropriate channel frequency.</p>		<p>If the call is not answered immediately, the scanning stops for 2½ minutes and you hear 'pips' every 4 seconds.</p> <p>After this period the transceiver carries on scanning.</p>
4.	<p>To stop scanning, press</p> 		<p>The scan indicator is no longer lit.</p>





CODAN

7. Programming channels

Your transceiver can store up to 15 channels. Channels may be copied and have their options modified, such as:

- S-selective call
- Upper Side Band mode (USB) or Lower Side Band mode.

You can create or change the transmit and receive frequencies of your transceiver from the front panel controls.



Where transmit frequencies are to be programmed, permission from the local licensing authorities or similar authorities should be sought.

Channels are stored in memory but can be reprogrammed or deleted at any time by the operator.

All displays in this section show examples of channel and frequency numbers. You must insert your selected channel and frequency numbers.



CODAN

8. Changing the setup options

Some of the setup options in this section can be completed by the user; others must only be carried out by qualified personnel, either at the Codan factory or by a Codan agent. A statement is made in the procedure whenever qualified personnel are required.

All displays in this section show examples of channel and frequency numbers. You must insert your selected channel and frequency numbers.

Setup option links

Some of the setup procedures may need a link to be moved inside the transceiver, while some need a link soldered inside the transceiver. The moveable link is called the front panel link (refer to page 8-2, *The front panel link*). The soldered link is called the microprocessor link (refer to page 8-4, *The microprocessor PCB link*).

The front panel link

The front panel link is located on the front panel display printed circuit board (PCB) assembly.

On front panel control transceivers, the PCB is located behind the numeric buttons and display. The link is located on a row of four horizontally mounted pins on the PCB (Figure 8.1).

On extended control transceivers, the PCB is located inside the control head. The link is located on a row of four vertically mounted pins on the PCB (Figure 8.1).

The front panel link can fit into four positions on the PCB, only three of which are used:

- 2** not used
- 1** used for set-up options
- F** used for front panel control transceivers
- E** used for extended control head transceivers.

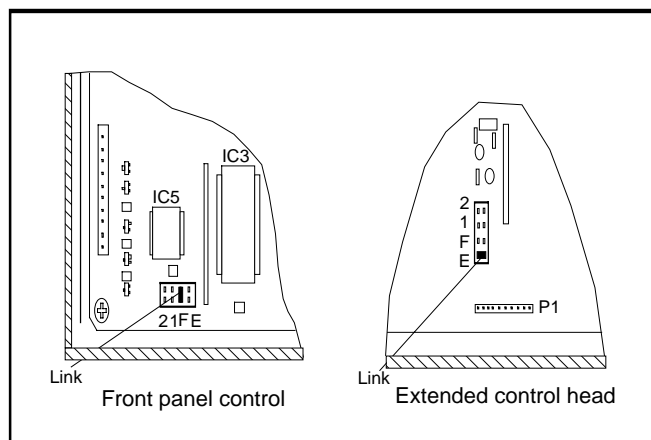

Figure 8.1: The front panel link



Changing the position of the front panel link

The front panel link is a black plastic moulding incorporating linked metal contacts. The contacts short together pins located on the front panel display PCB.



Extreme care should be taken when handling the transceiver to prevent damage to the components.

Step	Action
1.	Turn the transceiver off and disconnect the power.
2.	Remove either: <ul style="list-style-type: none">• the bottom cover of front panel control transceivers• the control head rear panel of extended control head transceivers.
3.	Make a note of the position you found the link (E or F). Move the front panel link from position F (front panel control) or E (extended control head) to position 1.
4.	You can now carry out the relevant set-up procedures.
5.	After completing the set-up procedures, turn the transceiver off and disconnect the power before returning the link to its original position.
6.	Replace the cover before reconnecting the power to your transceiver. Your transceiver is now ready for normal use.



The microprocessor PCB link

The microprocessor link is one that you will have to make and solder on the microprocessor PCB positioned on the underside of the transceiver (Figure 8.2).

The link must only be soldered across the number 2 pads (called the inhibit link). A link soldered across the number 2 pads prevents you from changing the inhibit setup options on channel programming.

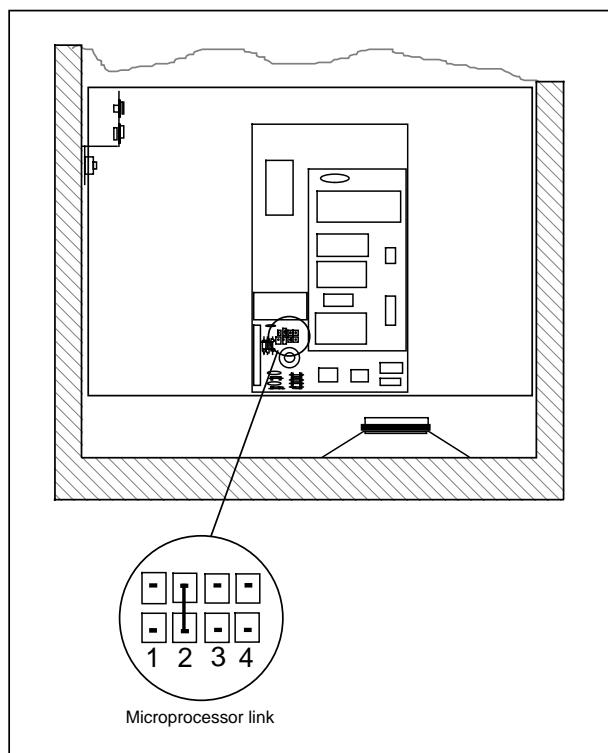

Figure 8.2: The microprocessor link



Inserting the microprocessor PCB link



Extreme care should be taken when handling the transceiver to prevent damage to the components.



This procedure must only be carried out by a qualified technician.

Step	Action
1.	Turn the transceiver off and disconnect the power.
2.	Lay the transceiver on its top with the front panel facing you.
3.	Remove the bottom cover of the transceiver.
4.	Locate the microprocessor PCB and the number 2 pads (refer to page 8-4). The link must only be fitted across the number 2 pads. Number 1, 3 and 4 pads are not used.
5.	Solder a suitable piece of wire across the number 2 pads (the Inhibit link).
6.	Carry out the relevant setup procedures.
7.	After completing the setup procedure, turn the transceiver off and disconnect the power before removing the link.
8.	Replace the cover before reconnecting the power to the transceiver. The transceiver is now ready for normal use.

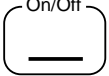

Reviewing setup options

This facility allows you to see what setup options have been enabled with the transceiver. You can review the setup options at any time. This procedure does not require you to move or install links in your transceiver.





Step	Action...	Display shows...	Remarks...
1.	Ensure your transceiver is off.	No display.	
2.	Hold down  and press 	Hold down the Display button until the display shows 	The display starts with the scan setup option.
3.	To scroll through the options press 	Shows each option.	Each press of the Display button scrolls to the next option: SCAN prog ENAbLE CHAN No inhib diSP S-CALL ENAbLE diSP CALL LONG diSP Addr CALL diSP Addr SELF diSP bEACON ON Ptt CutOut diSP bEEPS loud
4.	To exit the review mode and resume normal operations, press the PTT button.		

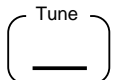
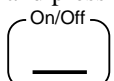
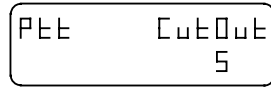

PTT timer

This facility stops the transceiver from being left on in the transmit state. If the transmit time exceeds the PTT timer setting, the transceiver reverts to the receive mode and an error message is displayed.

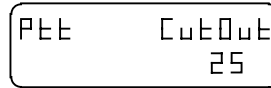
The timer is set at the factory to 10 minutes. You may turn this facility off, or vary the time between 5 and 35 minutes in five minute intervals.

Step	Action...	Display shows...	Remarks...
1.	Turn the transceiver off and move the front panel link to position 1.	No display.	Before moving the link, note its original position. Refer to the procedure on page 8-3.
2.	Hold down  and press 	Hold the Tune button down until the display shows 	This turns on the transceiver in PTT timer setup mode.
3.	Press  or 		The PTT 'time out' time can be changed from 5 to 35 minutes. Press either the  or  button to increase or decrease the time. Stop at the setting you require.

Changing the setup options

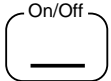
Step	Action...	Display shows...	Remarks...
4.	Press 	No display.	Your selection has been made and the transceiver is now switched off.
5.	Return the front panel link to its original position.		Refer to the procedure on page 8-3.
6.	Replace the cover before switching on your transceiver.		Refer to the procedure on page 8-3.



Enter a PIN (Personal Identification Number)



If you select a PIN for the transceiver, you have to enter this PIN each time you switch the transceiver on. If you fail to enter the correct PIN, the transceiver automatically switches off.



If a PIN code is set, the transceiver can only be operated by entering the PIN.

It is important that every person who uses the transceiver knows the PIN. Alternatively, do not set the PIN code.

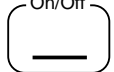
If you forget the PIN, you must return the transceiver to the factory.



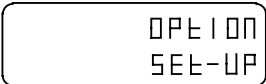
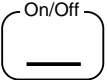

Step	Action...	Display shows...	Remarks...
1.	Turn the transceiver off and move the front panel link to position 1.	No display.	Before moving the link, note its original position. Refer to the procedure on page 8-3.
2.	Hold down  and press  .	Hold down the numeric 3 button until the display shows 	This switches on your transceiver in PIN setup mode.
3.	Use the numeric buttons to enter your PIN.	The display shows the number you enter.	You can select a number between 1 and 999999.



Step	Action...	Display shows...	Remarks...
4.	Press 		Your PIN number has now been registered within the transceiver.
5.	Press 	No display.	The transceiver is now switched off.
6.	Return the front panel link to its original position.		Refer to the procedure on page 8-3.
7.	Replace the cover before switching on your transceiver.		Refer to the procedure on page 8-3.

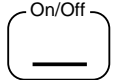

Changing or deleting a PIN

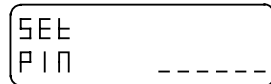
This procedure allows you to change or delete your PIN.

Step	Action...	Display shows...	Remarks...
1.	Turn the transceiver off and move the front panel link to position 1.	No display.	Before moving the link, note its original position. Refer to the procedure on page 8-3.
2.	Hold down  and press 	Hold down the numeric 3 button until the display shows 	This switches on your transceiver in PIN setup mode.
3.	Use the numeric buttons to enter your existing PIN, then press 	 	Example of existing PIN number 1234. You may now change or delete the PIN.

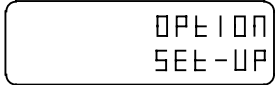
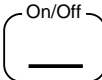
Step	Action...	Display shows...	Remarks...
4.	<p>To insert a new PIN, use the numeric buttons and press</p>  <p>To clear a PIN, do not insert new numbers, just press</p> 	<p>The display shows the number you enter, or if you cleared the PIN</p> 	<p>You can select a number between 1 and 999999.</p> <p>A new PIN is now registered, or the old PIN has been cleared.</p>
5.	<p>Press</p> 	<p>No display.</p>	<p>The transceiver is now switched off.</p>
6.	<p>Return the front panel link to its original position.</p>		<p>Refer to the procedure on page 8-3.</p>
7.	<p>Replace all covers before switching on your transceiver.</p>		<p>Refer to the procedure on page 8-3.</p>





Power-on settings

There are two power-on settings that may be set at any time without the need to move or install any internal links. These are the default settings that are always present when you switch on the transceiver.

- **Mute settings.** This facility allows you to select Voice Mute On, Voice Mute Off, or S'call Mute on.
- **Beep volume.** This facility allows you to set the beep volume to loud or soft.

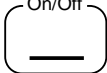
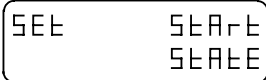

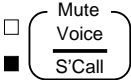
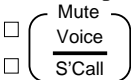
Mute settings

Step	Action...	Display shows...	Remarks...
1.	Hold down <input type="checkbox"/> Mute <input type="checkbox"/> Voice <input type="checkbox"/> S'Call and press On/Off 	Hold down the Mute button until the display shows 	This switches on your transceiver in Mute setup mode.
2.	Press <input checked="" type="checkbox"/> Mute <input type="checkbox"/> Voice <input type="checkbox"/> S'Call	No change in the display.	The Voice Mute is on when the Voice Mute indicator is lit. If you wish to select Voice Mute, proceed to step 4. If you wish to select S'call Mute proceed to step 3.

Step	Action...	Display shows...	Remarks...
3.	To select S'call Mute on, press  to select S'call Mute off press  again	No change in the display.	The S'call Mute is on when the S'call Mute indicator is lit. The Mute is off when neither indicator is lit.
4.	Press 	Reverts to normal display showing channel and frequency numbers.	Your selection has been made and you can switch off the transceiver.

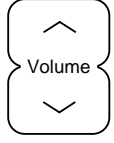
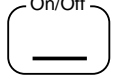
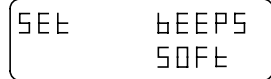
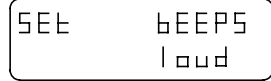

Beep volume

Step	Action...	Display shows...	Remarks...
1.	<p>Hold down either the up or down arrow</p>  <p>and press</p> 	<p>Hold down either of the volume buttons until the display shows</p>  <p>or</p> 	<p>This switches on your transceiver in beep volume setup mode.</p> <p>The display shows the last beep volume setting.</p>
2.	<p>Press either of the volume buttons to switch between the beep volume settings.</p>	<p>The display switches between soft and loud.</p>	
3.	<p>Press</p> 	<p>Reverts to normal display showing channel and frequency numbers.</p>	<p>Your selection has been made and you can switch off the transceiver.</p>



Changing the setup options



CODAN

9. Display messages







In addition to showing the normal channel information, the display is able to show messages indicating the results of an operation, such as an operator error or a system error.

These error or fault messages are generally accompanied by one or more 'beeps'.

If a transceiver fault is indicated, the transceiver must be switched off and tried again. If the fault re-occurs the transceiver must be sent to Codan or a Codan agent to have the fault rectified.

Messages are displayed for five seconds and then normal operation is resumed. Pressing any button or the microphone PTT button during this five second period immediately restores normal operation.

Messages and operator errors

No. of 'beeps'	Message displayed	Meaning
2		The automatic antenna has been satisfactorily tuned.
2		The automatic antenna has failed to tune.
2		An attempt has been made to transmit before the automatic antenna has been tuned. Wait until the automatic antenna has tuned. If a fault exists, refer to the antenna handbook for details.
1		An attempt has been made to enter more than 15 channels in the scan program.
0		A channel has been entered in the scan program.
1		An attempt has been made to transmit on a receive-only channel, or while the scan mode is selected. If the transceiver is scanning, press the Scan button to stop scanning. If the channel selected is a receive-only channel, select another channel.



No. of 'beeps'	Message displayed	Meaning
1	<div style="border: 1px solid black; padding: 5px; text-align: center;"> SCAN Error </div>	<p>An attempt has been made to select scan mode while the transceiver is transmitting, or no channels have been entered in the scan program.</p> <p>Check that the program has scan channels, if not select another program.</p>
1	<div style="border: 1px solid black; padding: 5px; text-align: center;"> Enter too hi Error </div>	<p>An attempt has been made to program a receive frequency higher than 30,000 kHz or a tone frequency higher than 2800 Hz.</p>
1	<div style="border: 1px solid black; padding: 5px; text-align: center;"> Enter too lo Error </div>	<p>An attempt has been made to program a channel with a frequency lower than 250 kHz or a tone frequency of 300 Hz or lower.</p>
0	<div style="border: 1px solid black; padding: 5px; text-align: center;"> CHL Tx FULL Rx </div>	<p>All 15 channels are programmed.</p>
1	<div style="border: 1px solid black; padding: 5px; text-align: center;"> CHL Tx USED Rx </div>	<p>The nominated channel is already programmed.</p>
1	<div style="border: 1px solid black; padding: 5px; text-align: center;"> prog inhib </div>	<p>There are four program inhibit options available. Refer to Section 7, <i>Checking if the inhibit link is fitted to the PCB.</i></p>

Display messages

No. of 'beeps'	Message displayed	Meaning
1		An emergency call or a selective call has been attempted on a channel where that function has not been enabled.
2		The microphone PTT has been active for a longer time period than set. Refer to Section 8, <i>Changing the setup options</i> .
1		A request for you to enter a selective call address.
0		A selective call has been received. This example shows a call received from station 428 on channel 2.
0		A call has been received on another channel.

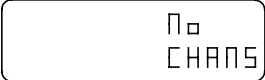

System errors

No. of 'beeps'	Message displayed	Meaning
3		<p>Internal synthesizer is unlocked. All transmission is inhibited and the receiver is muted.</p> <p>Turn the transceiver off and then try again. If the problem persists, the transceiver must be returned for service.</p>
2		<p>The external tuner has not completed a tune operation within five minutes.</p> <p>Turn the transceiver off and then try again.</p>
0		<p>No channels have been programmed into the transceiver.</p>



Reviewing the EPROM program content

With the transceiver on, hold down the On/Off button. The display shows the following test displays at three-second intervals. On releasing the On/Off button the transceiver is turned off.

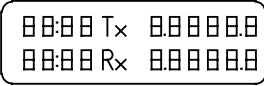
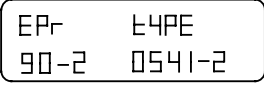
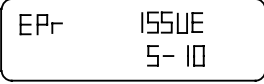
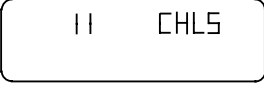
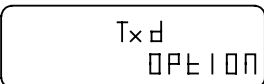
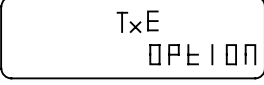
No. of 'beeps'	Message displayed	Meaning
0		Display lamp test—all segments must be on and all the indicators lit.
0		This shows the Program (EPROM) type number (for example 90-20541-2).
0		Program (EPROM) issue number (for example 5.10). Some indicator lamps turn off.
0		Shows the number of channels programmed by the factory or agent. This can be up to 15.
0		These displays indicate some of the options fitted to the transceiver. d indicates that the transceiver is inhibited from entering transmit frequencies from the front panel.
0		E indicates that the transceiver is enabled for entering transmit frequencies from the front panel.





CODAN

10. Front and rear panel sockets

Only suitably qualified personnel should use the information contained in this section. Failure to observe this criteria could result in damage to the transceiver.

Details are provided on the following sockets:

- microphone socket
- external alarm
- antenna control socket
- remote control socket.

Microphone socket

This socket is located on the front panel of the transceiver. It is used to connect the microphone to the transceiver.

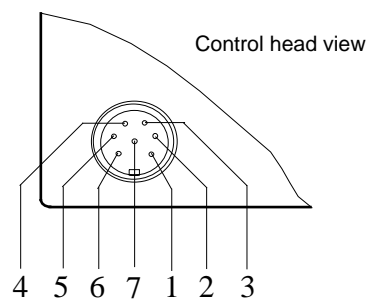

Pin No.	Designation	Pin No.	Designation
1	PTT ground	5	N/C
2	PTT (active low)	6	Audio output
3	Microphone input	7	Audio ground
4	Microphone ground		



External alarm socket

This socket is located on the rear panel of the transceiver.

- **Selective call alarm**

This facility allows an external alarm device to be connected to the transceiver. When a selective call is detected, internal relay contacts close across pins 2 & 3.

The contacts are rated for 1A at 50V DC.

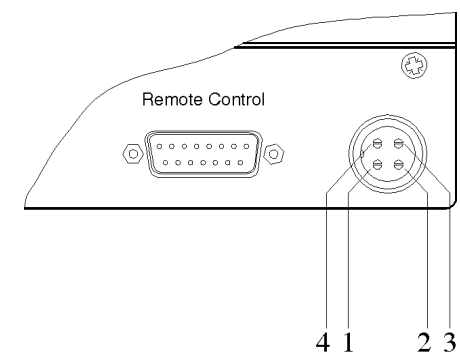

Pin No.	Designation	Pin No.	Designation
1	Not used	3	Relay contact
2	Relay contact	4	Not used



Antenna control socket

This socket is located on the rear panel of the transceiver. It allows you to connect an automatic tuning antenna to your transceiver.

There are two options available which determine the connections made to the pins on this socket:

- **Antenna control—standard**

This option allows an 8551 antenna driver to be connected to the transceiver.

- **Antenna control—option AD**

Fitting of this option is identified with a WARNING label fitted above the antenna control socket.

This option allows an 8558 automatic tuning antenna to be connected to the transceiver.

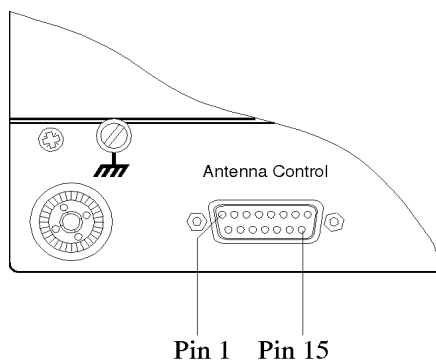

Antenna control—standard

Pin No.	Designation	Pin No.	Designation
1	Channel number Bit 3 (oc)	9	Channel number Bit 1 (oc)
2	Channel number Bit 4 (oc)	10	Channel number Bit 2 (oc)
3	N.C.	11	Tuned in (active low)
4	Tune in/out (active low)	12	Switched fused battery voltage
5	Scan (Active antenna, oc, active low)	13	Switched fused battery voltage
6	N.C.	14	Ground
7	N.C.	15	Ground
8	PTT out (+10V 1k Ω source)		

(oc) = Open Collector (Active high)



Antenna control—option AD

Pin No.	Designation	Pin No.	Designation
1	Channel number Bit 3 (oc)	9	Channel number Bit 1 (oc)
2	Channel number Bit 4 (oc)	10	Channel number Bit 2 (oc)
3	Disable (ground to disable)	11	Switched +12V Motor
4	Load	12	Switched fused battery voltage
5	+ 12V Scan	13	Switched fused battery voltage
6	Motor phase 1 (oc)	14	Ground
7	Motor phase 2 (oc)	15	Motor phase 3 (oc)
8	Motor phase 4 (oc)		

(oc) = Open Collector (Active high)



Remote control socket

This socket allows the control head to be connected to the transceiver.

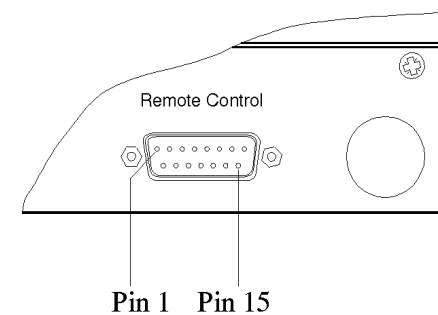

Pin No.	Designation	Pin No.	Designation
1	Loudspeaker	9	Ground
2	Remote PTT (active low)	10	Ground
3	Receiver audio input *	11	Transmit audio input (1.5V pp)
4	Power on (active low, pulse)	12	Receiver demodulator output (1.5V pp)
5	Data (I ² C Bus, 5V)	13	Receiver audio output *
6	Data line enable (I ² C Bus, 5V)	14	Interrupt (I ² C Bus, 5V)
7	Clock (I ² C Bus, 5V)	15	Switched fused battery voltage
8	Transmit lamp		

* Special: Adjusted to suit attached equipment.



Front and rear panel sockets



11. Specifications

Frequency range	Transmit: 2 to 24 MHz Receive: 250 kHz to 30 MHz
Channel capacity	15 channels
Operating mode	Single sideband (J3E; USB/LSB)
Transmitted power output	125 watts (PEP)
Supply voltage	12V DC nominal, negative earth Normal operating range 10.5V to 15V DC Maximum operating range 9V to 16V DC Reverse polarity protection is provided
Over voltage protection	Shutdown at 16V DC (nominal) for duration of over voltage
Supply current	Receive (no signal): 0.4A Transmit J3E voice: 6A (average) J3E two tone: 9—12A
Size and weight	9480 transceiver 250 mm W x 320 mm D x 78 mm H; 3.3 kg (excludes vehicle mounting frame) 9482 control head 190 mm W x 50 mm D x 75 mm H; 0.4 kg (includes mounting bracket)



12. Options and accessories

The following options and accessories are available for the 9480 transceiver.

Code Options

- AD Fit antenna driver interface for 8558 automatic tuning whip antenna.
- SE Program selective call encode (specify operating channels).
- M Fit morse facility.

Code Accessories

- 112 Vehicle installation hardware kit.
- 117 Vehicle mounting cradle–front entry complete with 6 metre DC power cable (normally supplied with the 9480).
- 118 Vehicle mounting cradle–top or bottom entry complete with 6 metre DC power cable.
- 704 Vehicle interference suppression kit.
- 711 Bulkhead mounting fuse holder for transceiver DC power cord–supplied with 32 amp fuse.
- 712 32 amp fuse for code 711.
- 2052 Service manual for type 9480 series.
- 9482 Control head complete with 6 metre interface cable fitted with connectors and hand PTT microphone.



